

The Public Summary of the Management Plan

Revision 08 (2019/2020)

Management objectives

- Achieve expected profit by in line with budgeted NSA & COP
- Achieve budgeted Rubber latex quantity
- Achieve budgeted Labour out-turn
- Compliance with five-year plans of crop projection, uprooting and re-planting
- Assessing biodiversity by monitoring species diversification
- Implementing environmental safeguards based on Environmental Impact Assessment (EIA)
- Improve socio-economic conditions of the worker force
- Provisions for monitoring rubber growth and dynamics
- Protect natural forest areas and restoration in high conservation value areas

Socioeconomic conditions of local communities

The estate sector in Sri Lanka has a history of almost 150 years. The British started the industry in the 1800s with 'imported' indentured labour from South India. Today's estate population are descendants of this labour that continued to be brought into the country until the 1940s. Sri Lanka's success as a lead exporter of tea in the 1960s and 1970s ensured the continuation of the industry despite manifold changes in the form of nationalisation, re-privatisation and the rise of the smallholder. Although the sector has evolved, it still retains aspects of the enclave structures and conditions that existed at its inception. Isolation and limited mobility has marginalised workers in the tea and rubber estates, and they have not reaped the benefits of development to the same extent as workers in other productive sectors of the economy. Households in the estate sector are among the poorest in the country. However, even though the development discourse frequently emphasises the marginalisation and backwardness of the sector, it must be acknowledged that

conditions have improved. Estate structures are less rigid and factors such as trade union activism, state interventions, sector specific development programmes, increased interaction with rural and urban sectors and greater integration with the mainstream economy, have resulted in noticeable micro level improvements. Despite these improvements the estate sector still lags behind in almost every indicator of poverty in Sri Lanka.

Harvesting areas

Sub FMUs of KVPL

Sub FMU	Rubber Area (Ha)	Forest Area (Ha)	Riverine (Ha)	Massy Land (Ha)	Conservation Area (Ha)	Others (Ha)	Total Extent (Ha)
Panawatte	696.32	43.11	0.35	1.5	44.96	259.02	1014.36
Dewalakande	539.35	65.35	13.53	1	79.88	91.66	710.89
Kiriporuwa	420.88	4.27	5.23	2.21	11.71	157.21	589.8
Lavant	443.92	9.59			9.59	115.69	569.2
Ganepalla	399.46	14.55			14.55	75.87	489.88
Urumiwela	514.81	6.77	5.11	1.37	13.25	181.54	709.6
Weoya	785.06	26.37	5.5	0.64	32.51	108.54	926.11
Kelani	231.65	24.08		1	25.08	83.09	339.82
Ederapola	431.14	10.99	4.02		15.01	196.92	643.07
Kalupahana	157.55	89.34	6.4	0.5	96.24	258.01	511.8
Total Area	4634.2	294.42	40.14	8.22	342.78	1527.55	6504.53

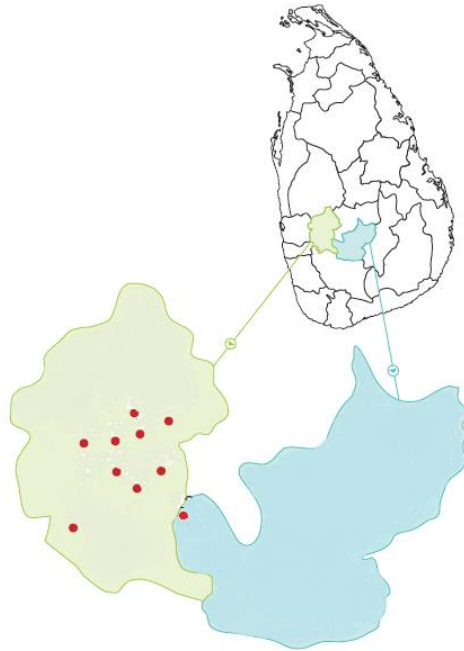

All the activities related to natural rubber management are conducted according to the Sri Lankan Rubber Research Institute guidelines.

1st tapping of the forest block shall commence when 60% of the trees in the clearing reaches a girth of 50 cm, measured over bark at a height of 120 cm from the highest point of graft union. All rubber trees having a girth lesser than 45 cm is not be tapped at the growth stage mentioned under indicator. The amount of latex harvested is not inflict systematically on the tree health or increase the tree's vulnerability to diseases. Tapping done close as possible to the vascular cambium, but without injuring the delicate cells.

Guidelines for Tapping

- First tapping of the bearing block (after 6th upkeep) shall commence when 60% of the trees in the clearing reaches a girth of 50 cm, measured over bark at a height of 120 cm from the height point of graft union.
- In such a clearing, all trees having a girth not less than can be tapped.
- All rubber trees having a girth lesser than 45 cm shall not be tapped at the growth stage of above particular block.

Marking a tree for tapping

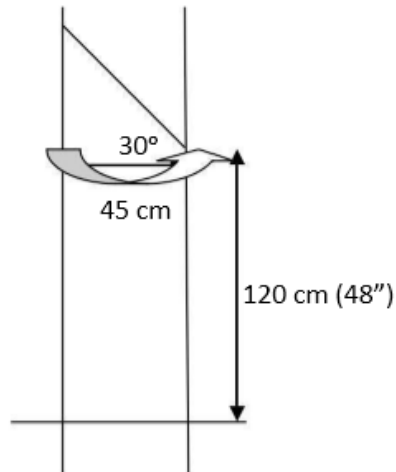

- Tapping panels are to be marked by dividing the trunk into 2 equal halves with vertical grooves
- Tapping is done only in one half (one panel) of the tree.
- Tapping angle should be 30° to the horizontal plain.

Annual Allowable cut

- All the harvest is calculated as per RRI (Rubber Research Institute) recommendations, And the Rubber tree uprooting and replanting is take place on mature with the approvals and recommendation by plantation ministry & RRI. Therefore it has to be with in Annual Allowable Cut limit.

Tapping Method

During tapping the original cut is systematically reopened by the removal (excision) of a thin shaving of bark from the sloping cut. The special knife used cuts a shallow channel along which the latex flows to a collecting vessel.

Tappable Tree

A tree with the girth of at least 50 cm, measured at 120cm from the highest point of the stock-scion union is reached

Tappable Clearing

60% of a clearing/smallholding should be of tappable girth before tapping is commenced.

Commencement of Tapping

November/December is an ideal period for commencement of tapping in a new clearing.

Tapping of a new clearing should not be undertaken during the Phytophthora season, i.e May to September each year.

Height of Opening Cut

Tapping cuts should commence at a height of 120 cm from the highest point of the union to the lower end of the tapping cut. Generally, on the base panels tapping is done from high left to low right using a Michie Gollidge Knife.

Slope and Direction of Cut

As the latex vessels run at an angle of $2.5 - 7^\circ$ to the vertical in an anti-clockwise manner, a greater number of latex vessels is cut and a greater yield is obtained when cuts are made at 30° to the horizontal sloping from high left to low right. For upward tapping of higher panels a 45° angle to the horizontal is advocated to prevent wastage of latex.

Marking of Trees

The tapping cut should be marked using a stencil made out of an aluminium sheet for tappers to achieve correct angle and length of cut and also to achieve correct bark consumption.

For marking of guide lines, firstly a vertical line (Neththi Kanu) is drawn on the tree commencing at a height slightly above the height of opening to reach the graft union. On this line the opening height is marked. Subsequently, half circumference of the tree is determined using a measuring tape or a string at two points and marked on the tree.

Another vertical line called 'Poi Kanu' is drawn through these two points from a point above the opening height to the graft union. With the aid of the appropriate stencil placed on the tree at the opening height with its handles parallel to both Neththi and Poi Kanu, lines are drawn for the tapping cut and guidelines with a high left to low right orientation.

The lowest point of the tapping cut (on the vertical line, on the right) is at 120 cm above the graft union.

The lines should be marked superficially using a pointed object such as a mounted needle. These marks should not be more than 1 mm deep as they are only required temporarily as guidelines for tapping.

After the marking of guidelines, the spout and the cup hanger are fixed. Subsequent guide lines are marked every year before commencement of tapping.

Depth of Tapping

The best yields can be obtained by tapping as close as possible to the cambium but without injuring these delicate cells. Tapping to a depth of up to 1 mm from the vascular cambium is therefore considered satisfactory.

Bark Consumption

In calculating the tapping life of rubber trees, a bark consumption of 0.125 cm (1/20") per tapping excision has been used. In general, the maximum number of tapping days that could be achieved in Sri Lanka is ca 320 per annum, therefore 160 days per tree on a V2S d/2 system. Hence, for the V2S d/2 tapping system, the annual bark consumption will be approximately 20 cm (0.125 cm x 160). Similarly for the 1/2S d/3 tapping system the annual bark consumption will be ca 14 cm (0.125 cm x 107).

Time of Tapping

The highest yield of latex is obtained by tapping in the early hours of the morning and late tapping will reduce latex yield due to increased transpiration leading to lower turgor pressure in the latex vessels.

Tapping Task

The number of trees assigned to a tapper to be tapped in a day is referred to as the Tapping Task. The stand/ha, terrain of the land, number of tapping cuts and distance between the block and the weighing point should be considered when fixing the task size. The normal tapping task varies from 275 - 325 trees.

Current Tapping Systems

Certain clones are capable of giving a relatively higher yield/tree/tapping (g/t/t/) than the other recommended clones. From such clones the

potential yield can be obtained by tapping a tree once in three days, i.e. d/3 frequency, whilst the other clones will need a higher frequency of tapping, i.e. d/2 frequency. If high g/t/t clones are tapped at d/2 frequency such clones are unable to sustain high yields and this will also lead to high incidence of Tapping Panel Dryness.

Tapping System	Clones
1/2S d/2	RRIC 100, RRIC 102, RRIC 117, RRIC 121, RRIC 131, RRIC 133, BPM 24, All RRISL 200 Series Clones, RRIM 717, PB 255, PR 255, PR 305
1/2S d/3	PB 28/59, PB 217, PB 235, PB 260, RRIC 130, RRII 105

The above tapping systems can be used for tapping of panels BO-1, BO-2 and BI-1, i.e. ca. 18 and 21 years of tapping using 1/2S d/2 and 1/2S d/3 systems respectively.

Intensified Tapping

In order to arrest the yield decline evident in Panel BI -2 and to harvest the maximum crop prior to uprooting of the rubber tree intensified tapping is recommended after the tapping of panel BI - 1.

There are two schemes recommended for intensified tapping and they are common to both d/2 and d/3 clones.

The duration of the intensification period is six years.

Year	Scheme 1	Scheme 2
1,2,3	2 x ½S (↑↓).d/3	¼S (↑) + ½S (↓) d/2
4 & 5	2 x ½S (↑↓).d/2	2 x ½S (↑↓).d/2
6	4 x ½S (↑↓).d/2	4 x ½S (↑↓).d/2

The upward cuts should be at an angle of 45° to the horizontal. Further, when two cuts are introduced they should be at least 52 cm apart to prevent overlap of the drainage area.

Tapping Panel Dryness

Normal yielding rubber trees will yield very little or no latex with the onset of tapping panel dryness. This change in the yielding potential of the tree can be gradual or sudden. Generally, high g/t/t clones are more susceptible to this syndrome. Over exploitation of trees, use of excessive yield stimulants, curtailing of fertilizer use whilst harvesting and tapping of wet panels favour incidence of dryness.

Panel Position

The position of the tapping panel during each year of the 24 years tapping cycle

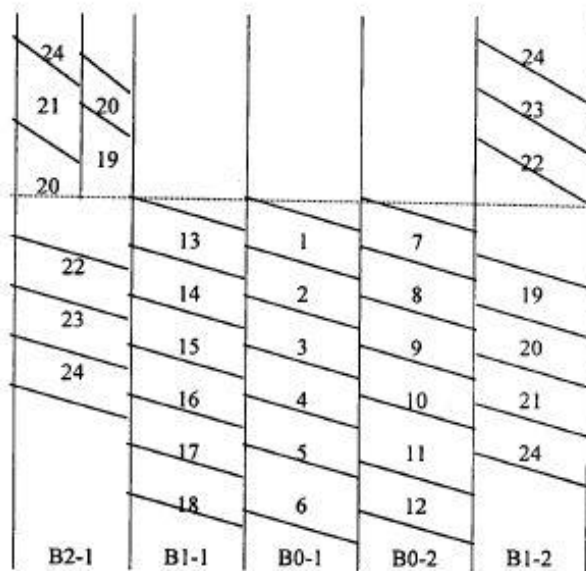

Year	Tapping Systems
1-18*	$1/2S \text{ d}/2$
19-21	$1/4S(\uparrow) + 1/2S(\downarrow) \text{ d}/2$
22-23	$1/4S(\uparrow) + 1/2S(\downarrow) \text{ d}/2$
24	$4 \times 1/2S(\uparrow\downarrow) \text{ d}/2$

(*1-24 if $1/2 S \text{ d}/3$ system is adopted)

Minimizing of Crop Losses Due to Interference of Rain on Tapping

- Tapping of panels made wet by rain is not recommended as it leads to panel diseases and interrupting flow of latex leading to wastage.
- Each year around 100 days of tapping are lost due to wet panels. Further, on about 50 days of the year tapping is commenced only ca. 10 am to 12 noons, after the panels dry up, i.e. late tapping.
- Also sudden showers occurring between tapping and latex collection result in latex getting washed away prior to collection. In a year ca. 10 - 15 such washouts are reported.
- No tapping, late tapping and washouts lead to about 30 - 35% loss of potential crop each year. This affects the income levels of land owners, tappers and factory workers.
- Hence, to avoid interferences from rain, rain guards have been introduced from 2020 for A and B.

Grooming

Mosses grow on the bark of some rubber trees and are capable of retaining moisture.

The moisture is released slowly and as a result a longer time is taken for the panel to dry even after the rains have ceased.

If the mosses found surrounding the tapping cut are removed it will help to dry up the panels quickly. Removing the mosses from an area 60 cm above the tapping cut and about 30 cm on either side and below the cut will be sufficient for this purpose.

This process, i.e. grooming, should be undertaken annually, before the onset of monsoons, on trees where mosses are found. This helps by increasing tapping days and converting late tapping days into normal tapping days.

Recovery Tapping

Ideally a rubber tree should be tapped every other day or once in three days depending on the clone.

This will make it possible to sustain the potential tapper and land productivity levels throughout the tapping cycle.

Anyhow, to recover the tapping days lost due to interference by rain, recovery tapping, i.e. an additional tapping in between two recommended tapplings, is recommended.

Recovery tapping leads to daily tapping and it negatively affects the growth and yield of trees.

Hence for all clones recovery tapping is not recommended during the first three years of tapping.

In clearings where recovery tapping is recommended, i.e. from the 4th year of tapping, only 2 or 6 such tapplings are recommended per week or per month respectively.

Also, if uninterrupted tapping is possible for a period in excess of a month recovery tapping during such periods will not enhance yields.

Rotation Tapping

In addition to the normal tapping gang another tapping gang is employed for tapping.

If an additional 25% of tappers are used in the second tapping gang, each tapping block will get an additional tapping once in about 8 days.

This system may not be practical at present due to the scarcity of skilled tappers. Further, this method also results in daily tapping of a tree to some extent.

Sub FMU assess environmental impacts before the commencement of site disturbing operations,

And Sub FMU do environmental impacts assessment (EIA) annually including potential impacts of management infrastructure, workers' activities and logging camps, and impacts related to the extraction of forest products such as equipment and transport network. The environmental impact assessments completed and documented before or during management planning in order to include its results in the planning process. The procedures of the sub FMU clearly identify the actions has taken to mitigate or reduce the environmental impacts identified during the assessment in the document.

- Hunting, capturing, extracting and trafficking wild animal in the estate is complete prohibited.
- Field officers should maintain wild life siting record.
- An inventory of wildlife and wildlife habitats should be established and e inventory should be updated once a year according to wildlife siting records.

Posters & awareness boards

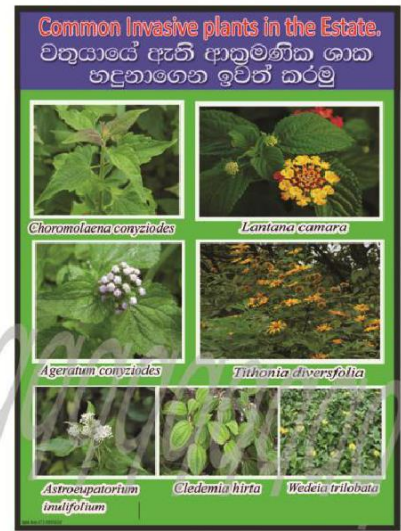
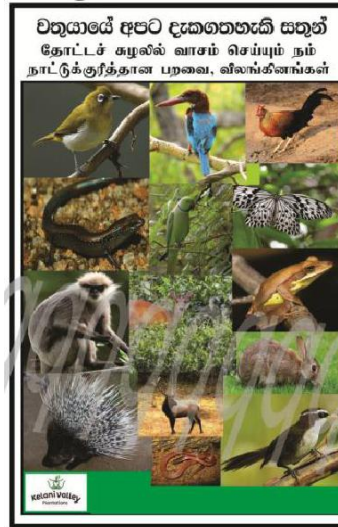
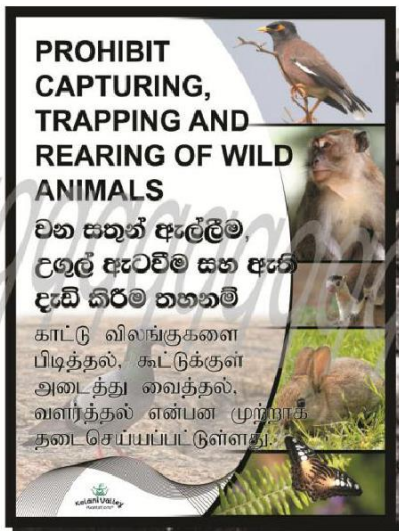

The sub FMU carried out a survey in order to identify, map and protect representative samples of existing ecosystems. The conservation zones identified by the sub FMU include representative samples of existing ecosystems.

Protection of biodiversity and RTE species

The biodiversity survey conducted by experts has identified the biological values and the presence of RTE species and their habitats. PPL ensures to protect them by using specific management actions with the participation of FMU workers and relevant stakeholders.

Conservation zones have been identified and marked on maps, and where necessary, on the ground.

The sub FMU have systems in place in order to ensure that all measures are taken against illegal or unauthorized hunting, fishing, trapping or collection within the sub FMU.

Biodiversity Assessment

Comprehensive biodiversity assessment will be carried out by the assistance of experts most probably from Government University and other recognized authorities. This assessment will be done within 10 sub FMUs which are belongs to scope of FSC certification. Under this assessment, identification of flora, faunal species and their habitats present basically in permanent sampling plots (PSPs) e.g. Conservation areas of the each estate will be monitored. Based on national flora, faunal species list native, exotic & RTE species will be marked. A Frequency of above assessment will be once in 06 years.

Rare, Threatened and Endangered Species

Through the assessment all Rare, Threatened and Endangered Species will be identified

Make plantation wildlife friendly through planting native plants native plants provide food and shelter for native wildlife.

Use of herbicides and pesticides close to conservation area is prohibited. Harassing wildlife is cruel and is illegal and prohibited and Wildlife habitat will to be protected.

Fauna and Flora Red List species

All flora and fauna species present in 10 Sub FMUs will be identified by multidisciplinary university expert team and information is going to include in the inventory called "Biodiversity Assessment Report". This project was carried out for all ten estates namely; Panawatte, Kiriporuwa, Weoya, Dewalakande, Urumiwela, Ganepalla, Ederapolla, Kalupahana, Lavant and Kelani. Estate managers have this inventory covering all 10 estates. Scientific name, common name and their conservation status are mentioned in this Biodiversity Assessment. Every manager has "The 2012 Red List of Threaten Fauna and Flora of Sri Lanka" in soft copy form. Critically Endangered, Endangered, Vulnerable flora and fauna species can be identified them by above two records to Estate Community.

All available ecosystems are marked in the estate & divisional maps. And necessary permanent sampling plots (PSP) are established in order to monitor. All PSPs also marked in the maps.

Sampling Designs

Permanent sampling plots (PSPs) have been demarcated and identified those areas in the estate maps. This girth measuring is required to carry out annual basis. Biodiversity assessment should be carried out by an

expert or team of experts once in 06 years. Assessment report will be kept in the estate office for reference.

Layout of sample

20 m X 20 m are the dimensions of the PSP. PSPs are demarcated by white concrete posts which has yellow band on top.

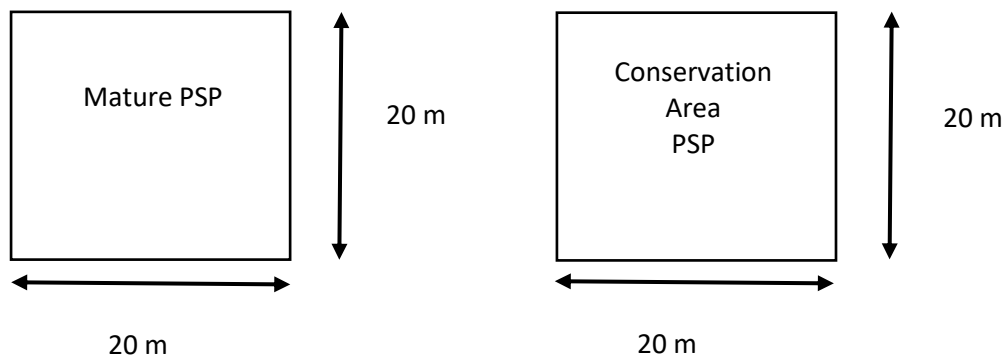

Data Collection

Data is collected annually by field officers under executive supervision from above PSPs.

Techniques adopted in rubber timber uprooting

Uprooting is carried out along the contour lines.

- Three categories are identified as per the slope of land.

1. Gradient $0 - 45^\circ =$ Low
2. Gradient $45^\circ - 60^\circ =$ Moderate
3. Gradient $60^\circ \leq$ High

- Before Uprooting

- Sketched Topography Map with all necessary information is prepared

The site map is contain information on topography, slope as per the gradient, slope categories, water sources, and existing estate roads and planned skidding routes.

This map is generated through a professional land surveying or using GPS mapping technology or Manual mapping. And all necessary resources is marked by the surveying professional or sub FMU executive staff.

- Environment impact Assessment (EIA) is conducted
- Copy of map & conducted copy of EIA is given to contractor. The agreement will be signed with contractor in order to give instruction to follow standard uprooting procedures to minimize environment disturbance on Soil, Water & biodiversity.
- According to the slope categories method of uprooting is carried out by the contractor.

If it is low (Gradient 0 – 45°) - Heavy machinery model no. 60 excavators is used.

If it is moderate (Gradient 45° – 60°) - Either model no. 30 excavator or monkey grubber are used. If the slope classification is high (Gradient 60° <) - then monkey grubber should be used for uprooting or trees can be removed manually

If the Site contain any water ways (Seasonal & Permanent) – 10 meters from water in both site has to be marked and trees has to be removed manually or using monkey grubber.

- Any Fauna or Flora habitats is not disturbed during the uprooting process
- As per EIA corrective actions is taken at the field in order to ensure least disturbance to environment on Soil, Water & biodiversity while uprooting and just after uprooting.
- Skidding routes is established along the contour lines.

For holloing for replanting

If it is low (Gradient 0 – 45°) - model no. 30 excavator is used.

If it is moderate (Gradient 45° – 60°) - model no. 30 excavator is used.

If the slope classification is high (Gradient 60° <) – manually done.

If the Site contain any water ways (Seasonal & Permanent) – 10 meters from water in both site manually done.